

Isolated RS-232C Micro Converter for USB 2.0  
**COM-1P2-USB**



**Features**

**Max. 921,600bps RS-232C Serial Communication**

The COM ports of this product support up to 921,600 bps. The product has one isolation-type RS-232C-standard COM port channel.

**Compatible to USB 2.0/USB 1.1 and not necessary to power this product externally as the bus power is used**

Compatible to USB 2.0/USB 1.1 and capable to achieve high speed transfer at Full Speed (12Mbps). Not necessary to power this product externally as the bus power of USB is used.

**Possibly used as Windows, Linux-standard COM ports**

Combining the product with our device driver COM-DRV makes it possible to use the product in the same manner as the COM ports of a PC. This product supports communication using DCB structures in the Win32 API and Linux-standard system calls. In addition, supplies a diagnostic program to confirm hardware operation and to perform a communication test with equipment.

**Isolation between channels and between PCs, surge protection for all signal lines**

Electric isolation is provided between channels and between PCs. This prevents electric noise between PCs and external circuits. As surge protection is provided on all signal lines, you can safely use the products in environments where you are concerned about surges causing incorrect operation or damage to the PC.

**Up to 127 converters can be installed on a single PC**

Using a USB hub allows you to install up to 127 converters to a single PC.

**Equipped with buffer memory for transmitting 128 bytes and receiving 384 bytes**

This product is equipped with buffer memory for transmitting 128 bytes and receiving 384 bytes. These are FIFO format, useful for high speed communications and to reduce the load to the CPU when transmitting/receiving.

**Equipped with 9-pin D-SUB connector for direct connections to devices such as modems**

Use of a 9-pin D-SUB connector (female type) allows you to connect it to a device such as a modem directly. It can also be connected to the cable of another 9-pin D-SUB connector (female type), if the gender changer is connected. (\*Installed before shipment)

**The control line for RS-232C can be controlled and monitored by software**

The control lines for RTS, CTS, DTR and DSR can be controlled and monitored using software.

These products are an isolated micro converter for converting the USB port of PC into RS-232C serial communications. The product has one RS-232C-standard COM port channel that isolates the bus line with the PC.

These products support a baud rate of up to 921,600bps and has separate 128-byte / 384-byte buffer memory for transmit and receive.

Windows/Linux device driver is supported with this product.

The COM-1P2-USB is successors to the COM-1P(USB)H. They are compatible with each other in terms of product shape, connector shape, and signal layout, making migration easy.

When reconnecting to a USB port in a Windows environment, the COM number may not be recognized correctly. For details, see "Differences between this product and our earlier models".

- \* Specifications, color and design of the products are subject to change without notice.
- \* The contents in this document are subject to change without notice.
- \* Visit the CONTEC website to check the latest details in the document.
- \* The information in the data sheets is as of December, 2025.

**Specifications**

**Function specification**

Item	Specifications
Number of channels	1 channel
Interface type	RS-232C
Isolation	Bus isolation
Isolation voltage	300VDC
Transfer method	Asynchronous serial transfer
Baud rate	300 - 921,600bps*1 *2
Data length	7, 8 bit / 1, 2 stop bit
Parity check	Even, Odd, Non-parity
Controller chip	XR21V1410 Mounting the FIFO memory as the common buffer of RS-232C communication and USB. Sending: 128byte / receiving: 384byte (by the view of PC)
Connecting distance	Within 15m
Operation guaranteed voltage	5V±5% *3
Power consumption *3	5VDC 280mA (Max)
USB bus specification	USB Specification 2.0/1.1 standard
Power consumption	Only bus power
USB transmission speed	12Mbps (full speed mode)
Cable length	1.8m
Physical dimension (mm)	78.3(W) x 20.5(D) x 36.5(H) 91.0(W) x 20.5(D) x 36.5(H) (When connecting gender changer)
Weight	130g 140g (When connecting gender changer)

- \*1 These items can be set by software.
- \*2 Data transmission at high speed may not be performed normally depending on the environment including the type of status of connected material of cable and environment.
- \*3 It doesn't correspond to Low-power Bus-powered Function (4.4V operation).

**Installation Environment Requirements**

Item	Specifications
Operating ambient temperature	0 - 50°C
Operating ambient humidity	10 - 90%RH (No condensation)
Floating dust particles	Not to be excessive
Corrosive gases	None
Standard	VCCI Class A, FCC Class A CE Marking (EMC Directive Class A, RoHS Directive), UKCA

**Gender changer specification**

Item	Specifications
Engagement	9 pin D-SUB male, thumb screw : UNC#4-40 (inch screw threads) x 2
Wiring	Straight over entire length
Physical dimension (mm)	18.0(W) x 12.5(D) x 31.0(H)
Weight	10g

## Support Software

Name	Contents	How to get
Windows Version Serial communication driver COM-DRV(WDM)	Software that makes it possible to use the product in the same manner as the COM ports of a PC running Windows. This software supports communication using DCB structures in the standard OS Win32 API, and the SerialPort class in the .NET Framework and the pySerial module in Python. Various sample programs such as C# and Visual Basic .NET, Visual C++, Python etc. and diagnostic program useful for checking operation is provided.	Download from the CONTEC website *1
Linux Version Serial communication driver COM-DRV(LNX)	Software that makes it possible to use the product in the same manner as the COM ports of a PC running Linux. This software conforms to Linux-standard tty drivers, and the pySerial module in Python. The software includes various sample programs such as gcc (C, C++) and PYTHON programs.	Download from the CONTEC website *1
<b>Coming soon</b>		

\*1 Download the files from the following URL.  
<https://www.contec.com/download/>

## Included Items

Product [COM-1P2-USB] (gender changer attached)...1  
Please read the following ... 1

## Physical Dimensions

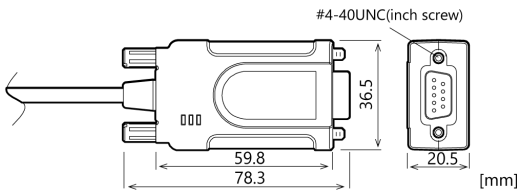

## Physical Dimensions

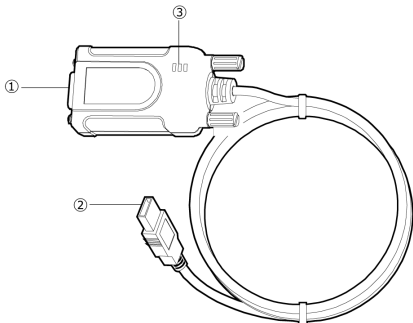

No.	Name	No.	Name
1	Interface connector (9pin D-SUB(Female))	3	LED Indicator
2	Interface connector (USB Type-A)		

## Interface connectors

### Pin assignment of interface connectors

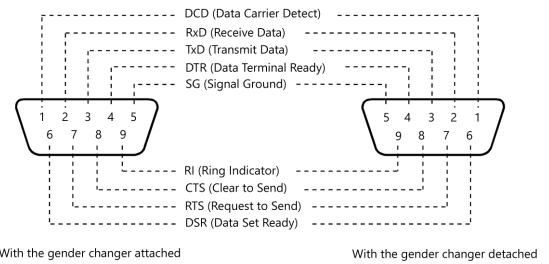

### Directly Connecting the Product

The RS-232C interface of this product uses a 9 pin D-SUB (female) connector.

You can connect the product directly to a device such as a modem if it has a D-SUB 9 pin (male) connector. For connection to such a device, detach the gender changer.

Note, however, that the product cannot cross-connect directly such as COM port on a PC to a device even though the device has a 9 pin D-SUB (male) connector.

### Example Connection to a Modem (Cableless)

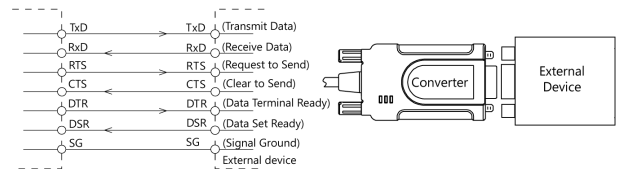

### Connecting the Product with a Cable

Use a cable when you use the gender changer to connect the product to the 9 pin D-SUB (female) RS-232C interface of the external device or when a straight connection cannot be made.

The cable to be used may be different depending on the device to connect the product to. Check the specifications of the external device, then prepare the straight type or cross (reverse) type of cable depending on the cable type (specifications). If signal conductors in the connectors require treatment, treat them according to the specifications.

### Example Connection to a PC (gender changer + cross cable)

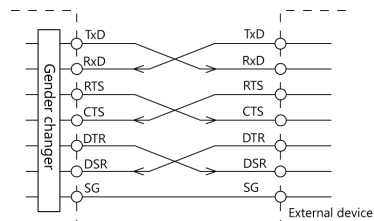

### Example Connection to a device

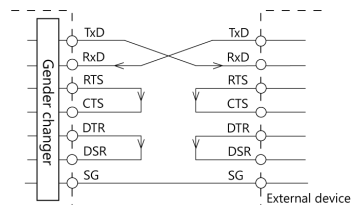

### Example use of gender changer

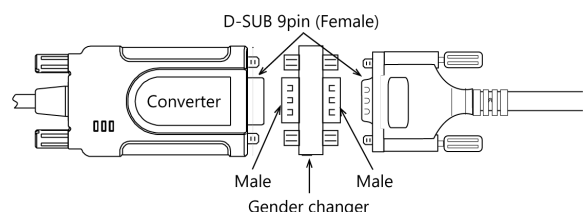

**⚠ CAUTION**

Connection with conductors wired incorrectly can result in failures in the product and external device.

**Gender changer**

The interface connector of this product is a 9 pin D-SUB (female) connector.

The product is shipped with the gender changer attached to the interface connector. When connecting the product with a screw-locked (female) cable, leave the gender changer attached to the connector.

When connecting the product to a device having a 9 pin D-SUB (male) connector using a straight cable, remove the gender changer and connect the product directly to the device.

**Differences between this product and our earlier models**

COM-1P2-USB is compatibility in terms of product dimensions, connector, signal arrangement, and software as COM-1P(USB)H, it is easy to migrate from the existing system.

But when the product is reconnected in Windows, the COM number is set as follows depending on the USB port or a product.

**Case 1: When the same model is connected to a different USB port**

Item	COM-1C2-USB COM-1P2-USB	COM-1(USB) COM-1P(USB)H
<b>When a different model is connected to the same USB port</b>	The COM number changes.	The COM number does not change.

**Case 2: When a different model is connected to the same USB port**

Item	COM-1C2-USB COM-1P2-USB	COM-1(USB) COM-1P(USB)H
<b>When a different model is connected to the same USB port</b>	The COM number does not change.	The COM number changes.

**⚠ CAUTION**

For details on changing the COM number, refer to the help included in the device driver, or the online help made available on the Contec website.

**Other differences**

- Compatible with Windows 10 or later (For details, please refer to Help or Online Help.
- COM-1P2-USB can be used with Windows version serial communication driver COM-DRV(WDM) Ver. 10.00 or later. When using COM-1P(USB)H and COM-1P2-USB together, the serial communication driver needs to be updated.

For other information, contact your retailer.